

# Deckorators® Contemporary Cable Installation Instructions for Level Runs

## Tools Required for Installation

- 5/32" Drill Bit
- 1/4" Drill Bit
- 29/64" Drill Bit
- 1/8" Hex Wrench
- 7/16" Wrench
- RFXPL-KEY
- Cut Off Kit (mandrel)
- Cut Off Kit (wheel)

### Cut-off Tool

Used to cut cable flush with the end of the Pull-Lock® fittings, and to cut excess threads off stud-type Receivers. Includes mandrel and two cut-off wheels.

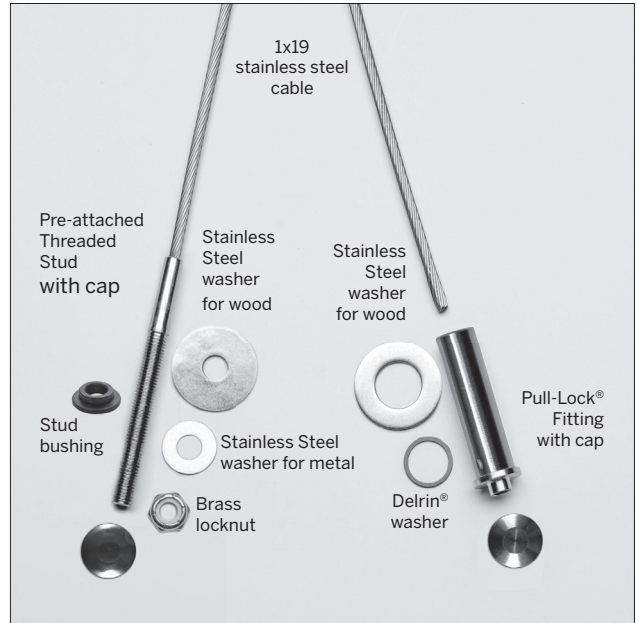
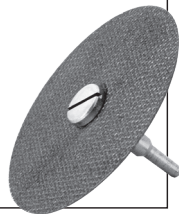

**NOTE:** Parts must be kept clean and free of debris before installation for best results.

## A. Drill Posts

Hole size for 1/8" or 3/16" dia. cable installation

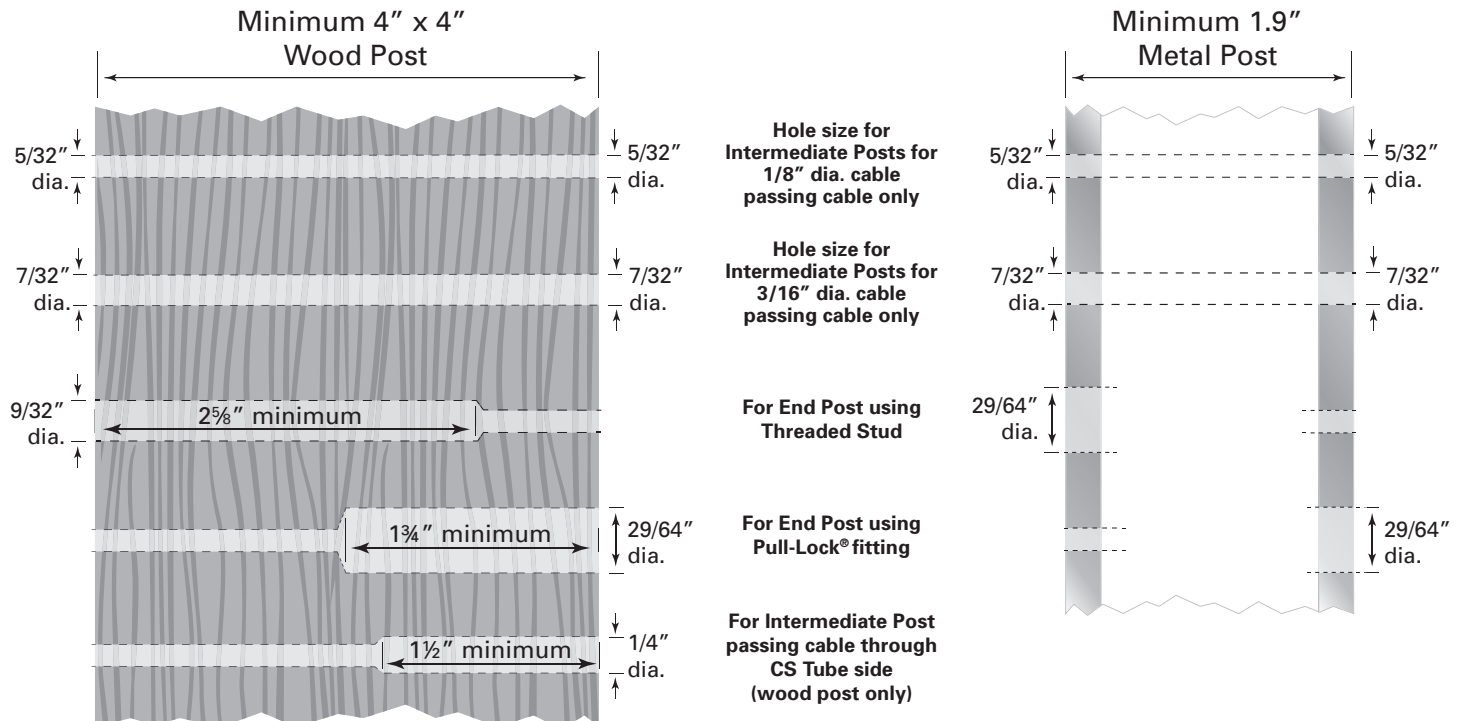

## B. Install Tensioning Terminal

1. Install the Threaded Stud end first. Feed the cable and stud through the end post. If using metal posts, start by inserting the plastic stud bushing into the pre-drilled hole in the post. Slide the stainless steel washer (smaller for metal post, larger for wood post) onto the Threaded Stud and start the brass locknut onto the threads as far as possible by hand.



## C. Feed Cable through Intermediate Posts

1. Feed the bare end of the cable through all intermediate posts/cable braces and through the end post where you will be installing the Pull-Lock® fitting.

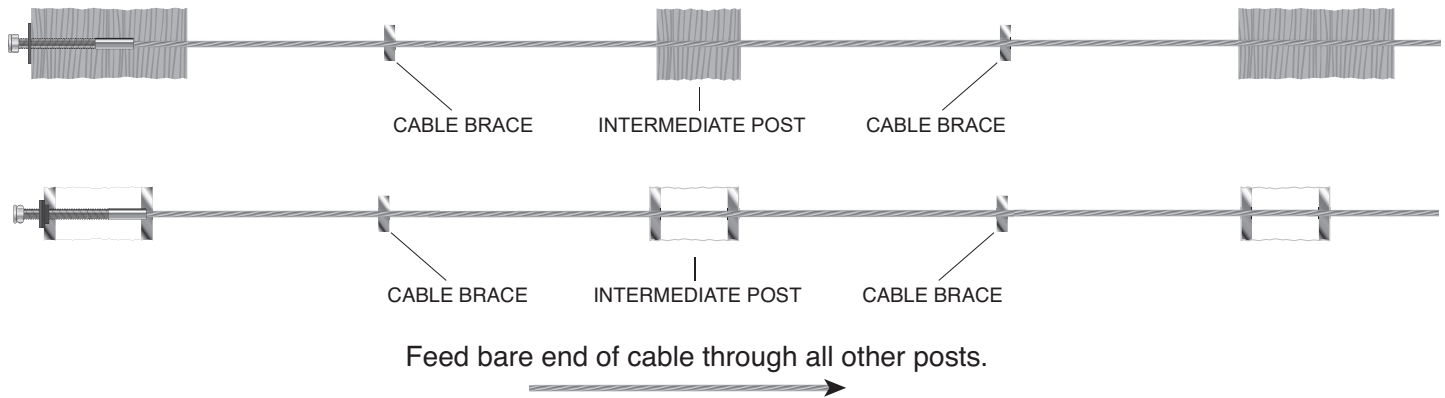

## D. Feed/Crimp Cable through Corner Posts

Instructions for going through corners for both wood and metal posts are available at our website. Scan the QR Code at right with your smart phone, or call us at 800-851-2961 and ask for Cable Railing Technical Support and we'll email it to you.



## E. Install Swageless Terminal

1. Slip the appropriate washer over the body of the Pull-Lock® fitting (Delrin® for metal post, stainless steel for wood post).
2. Rotate the Pull-Lock® fitting clockwise as you push it onto the cable. If the cable begins to "unravel," you are rotating the fitting in the wrong direction.

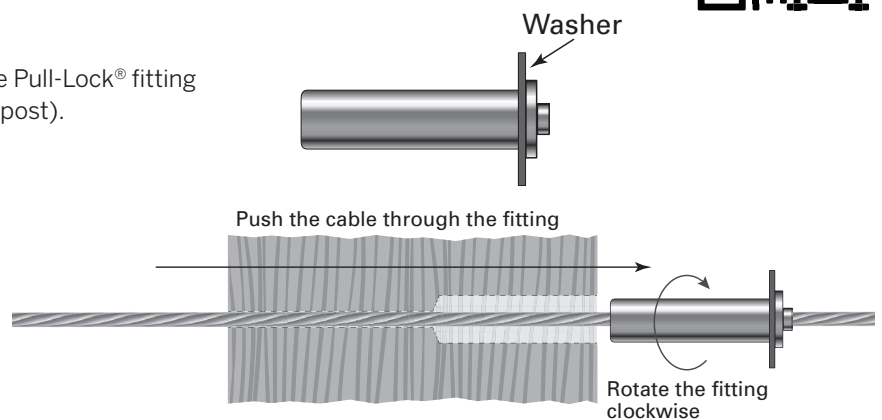

Note: If you have trouble inserting the cable into the fitting, it may be because the locking wedges have become stuck. This is not a defect! Here's what you can do to "free the wedges" — For Pull-Lock® or Push-Lock® fittings for 1/8" cable, using either a PL-KEY or 1/4" diameter bolt, insert the PL-KEY or bolt into the hole and press until the wedges move freely. Perform the same operation for a 3/16" Pull-Lock® or Push-Lock®, except use a 16d nail or another tool with 1/8" or smaller diameter. Anything larger than what is recommended can actually get stuck inside the fitting – NOT what you want!

3. Push the Pull-Lock® fitting along the cable and firmly into the hole in your post. While holding the Pull-Lock® fitting against the end post, pull the bare end of the cable to remove as much slack in the cable as possible.

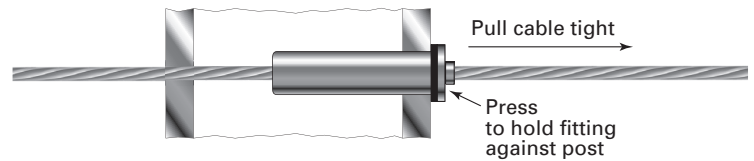

## F. Tension Cables

1. Return to the Threaded Stud end post. Insert an 1/8" hex wrench into broached opening on the tip of the stud. Tighten the locknut with a 7/16" wrench while holding the hex wrench to prevent the stud from turning.

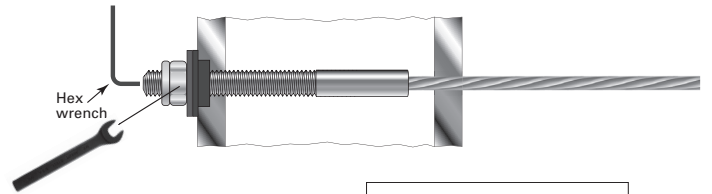
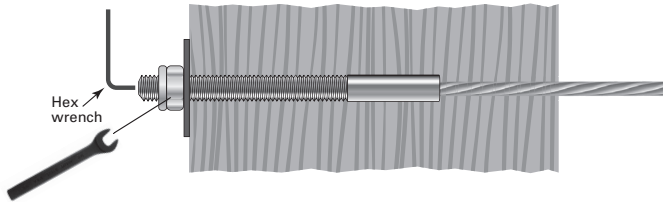

2. Tension all cables to desired amount in sequence, beginning with the center cables, moving up and down toward the top and bottom. As you tension each cable, give it a sharp pull downward mid-span to help set the wedges, then re-tension as necessary in the same sequence. Be aware that the cable may move as much as 3/16" toward the tensioning terminal as the wedges seat.

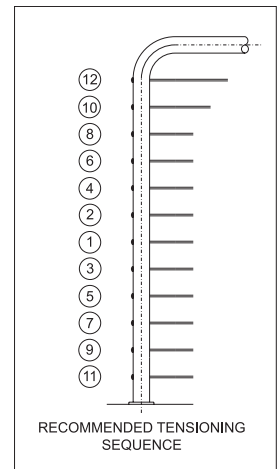

## G. Trim Excess Cable

1. When all of the cables are tight, cut off any exposed thread as near to the locknut as possible by using a cut-off wheel or hack saw.

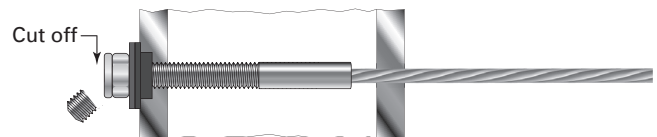
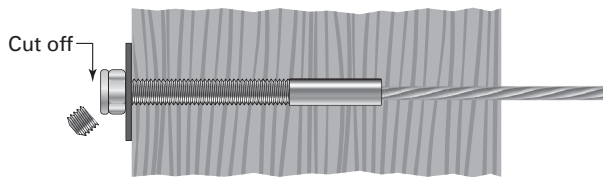

2. Twist the cap over the locknut.

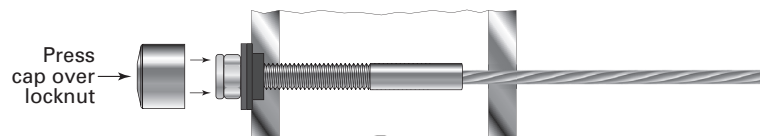

3. Return to the swageless terminal. Cut the cable flush with the hole in the back of the fitting using a cut-off wheel.

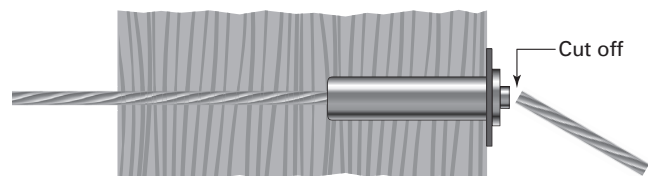

4. Twist the cap onto the lip of the Pull-Lock® fitting.

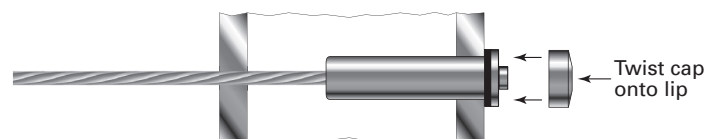

# Decorators® Contemporary Cable Installation Instructions for Stairs

## Tools Required for Installation - see page 1, plus:

- Hammer
- Small block of wood

## A. Drill Posts

Neither the threaded stud nor the Pull-Lock® will reach all the way through wood end posts, so you will need to add post protector tubes (aka CS-TUBE) to the inside face of your end posts to protect the wood from the cable as it exits the post at the stair angle. Not needed for metal posts.

### Hole size for 1/8" or 3/16" dia. cable installation

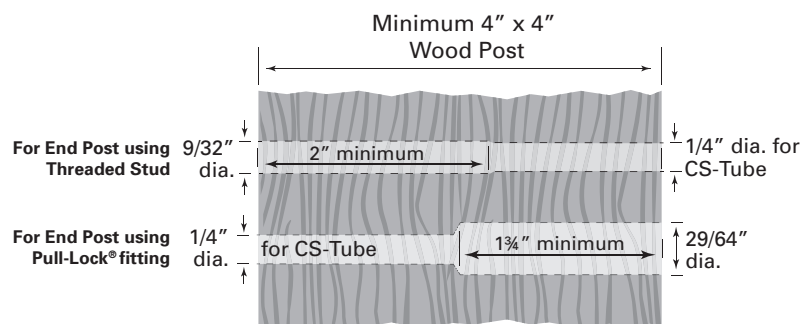

Intermediate posts are drilled on the angle.

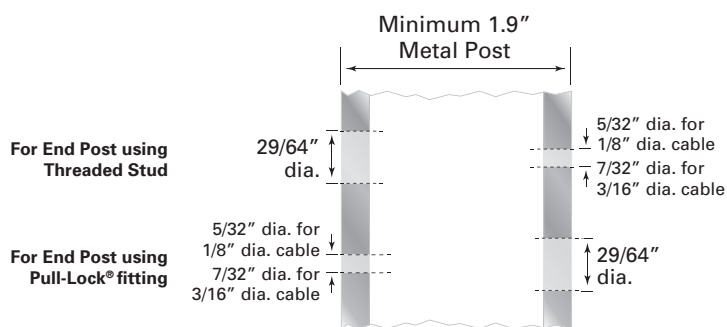
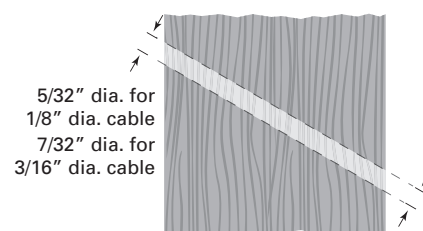

Intermediate posts are drilled on the angle.

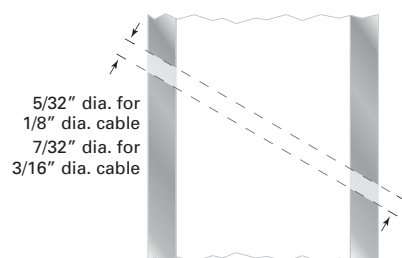

## B. Install Tensioning Terminal

1. If a wood post, insert the post protector tube first into the face of both end posts. Force each tube into post so it is flush with post face.

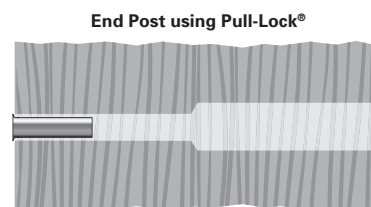
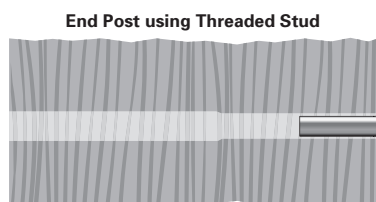

2. If using metal posts, start by inserting the plastic stud bushing into the pre-drilled hole in the post. Slide the stainless steel washer onto the threaded stud (smaller for metal post, larger for wood) and start the brass locknut onto the threads as far as possible by hand. Feed the cable through the end post, pulling the threaded stud into place.

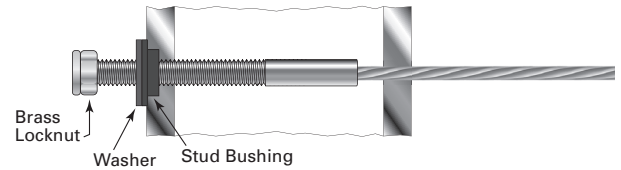
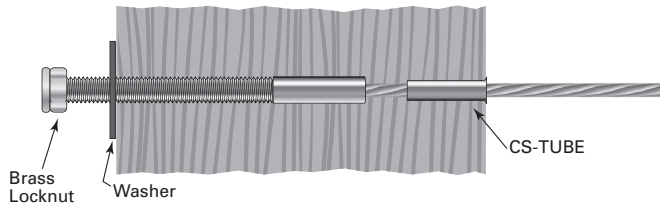

### C. Feed Cable through Intermediate Posts

1. Pass bare end of cable through intermediate post(s), and through other end post (which includes post protector tube if wood post).

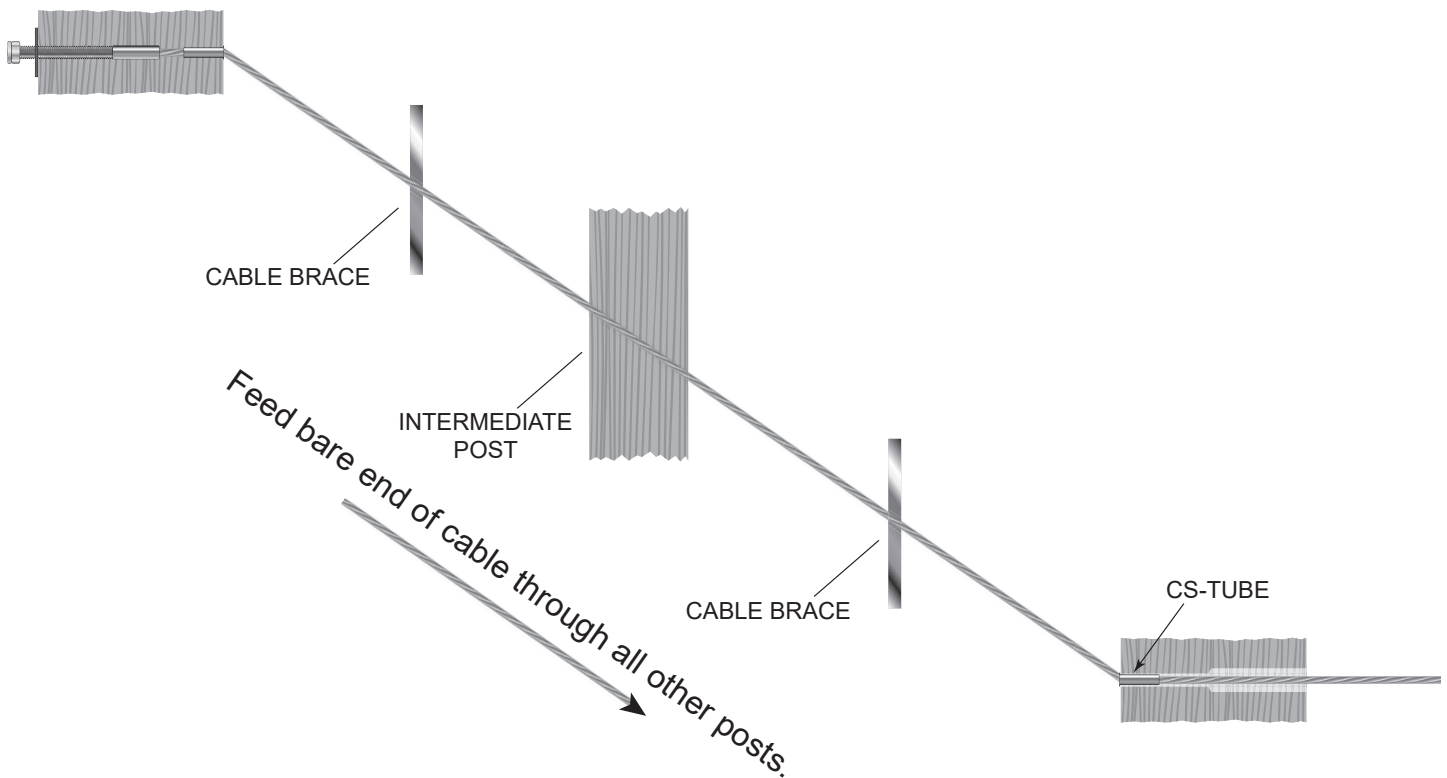

### D. Feed/Crimp Cable through Corner Posts

As this section deals with passing cables through corners, which you will not be doing with stairs, please proceed to Section E.

## E. Install Swageless Terminal

1. Push the bare cable through the other end post and mark the cable at the point where it enters the end post.

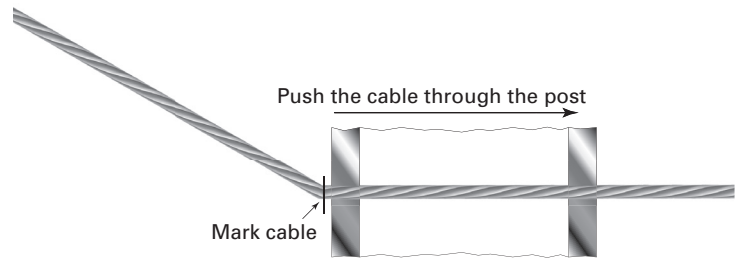

2. Slip the appropriate washer over the body of the Pull-Lock® fitting (Delrin® for metal post, stainless steel for wood post).

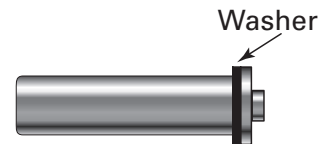

3. Rotate the Pull-Lock® fitting clockwise as you push it onto the cable. If the cable begins to “unravel,” you are rotating the fitting in the wrong direction.

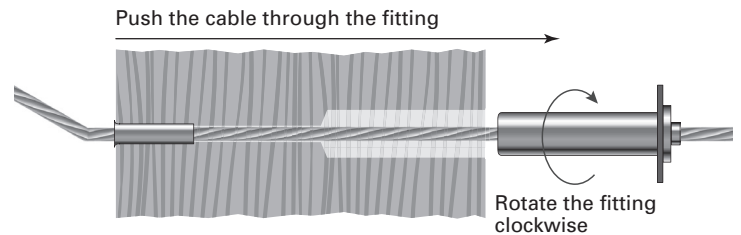

**Note:** If you have trouble inserting the cable into the fitting, it may be because the locking wedges have become stuck. This is not a defect! Here's what you can do to “free the wedges” —  
For Pull-Lock® or Push-Lock® fittings for 1/8” cable, using either an PL-KEY or 1/4” diameter bolt, insert the PL-KEY or bolt into the hole and press until the wedges move freely. Perform the same operation for a 3/16” Pull-Lock® or Push-Lock®, except use a 16d nail or another tool with 1/8” or smaller diameter. Anything larger than what is recommended can actually get stuck inside the fitting – NOT what you want!

4. Push the Pull-Lock® fitting along the cable and firmly into the hole in your post. Pull on the cable (cable gripping pliers are helpful for this) to create as much tension as possible as you seat the Pull-Lock® fitting into the hole.

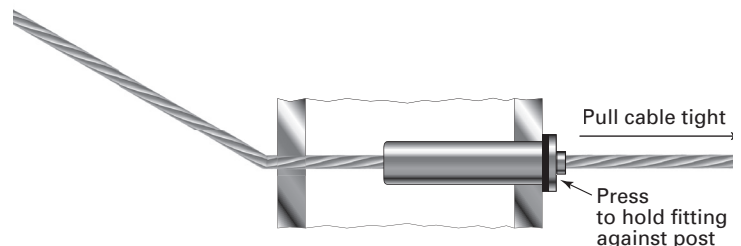

## F. Tension Cables

- Return to the Threaded Stud end post. Insert an 1/8" hex wrench into broached opening on the tip of the stud. Tighten the locknut with a 7/16" wrench while holding the hex wrench to prevent the stud from turning.

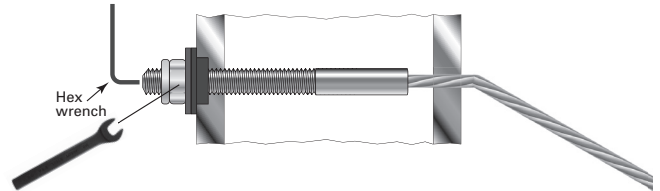
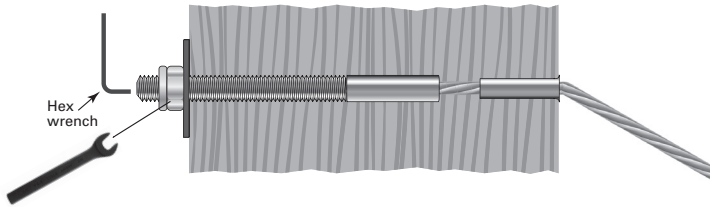

- Tension all cables to desired amount in sequence, beginning with the center cables, moving up and down toward the top and bottom. As you tension each cable, give it a sharp pull downward mid-span to help set the wedges, then re-tension as necessary in the same sequence. Be aware that the cable may move as much as 3/16" toward the tensioning terminal as the wedges seat.

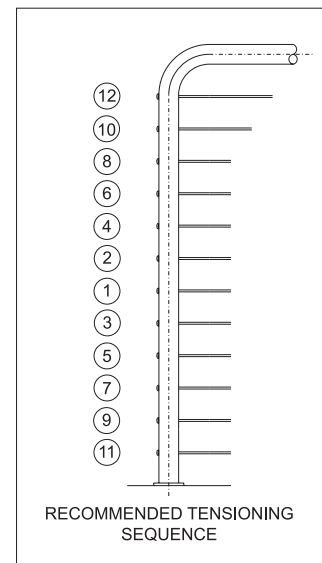

- At both ends of the run, you are going to create a sharp bend in the cable where it exits the post (post protector tube in the wood post) by placing a block of wood (for protection of the post) on the cable next to the post / tube at the face of each post and striking it with a hammer. If tension has diminished slightly as a result of the bending of the cable, re-tension the threaded stud back up to desired amount, as in Step F-2.

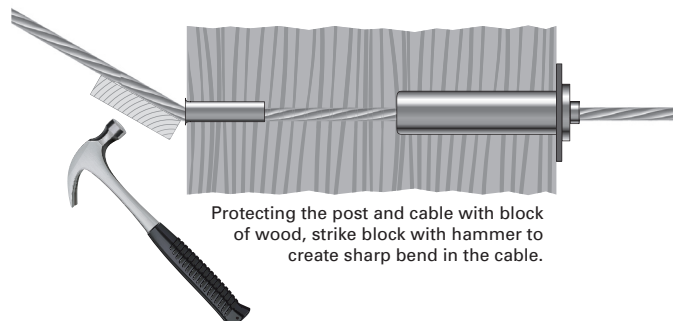

### G. Trim Excess Cable

1. When all of the cables are tight, cut off any exposed thread as near to the locknut as possible by using a cut-off wheel or hack saw.

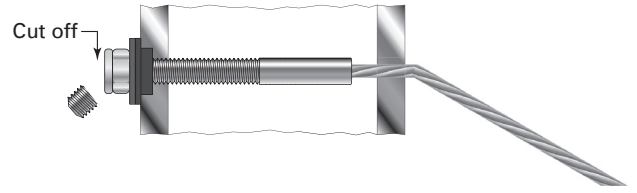
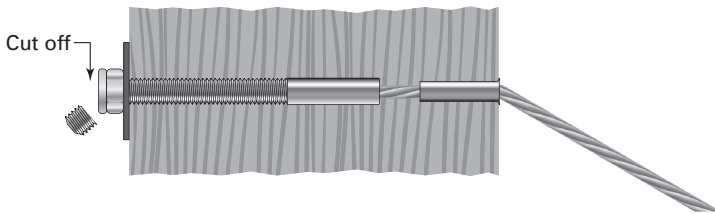

2. Twist the cap over the locknut.

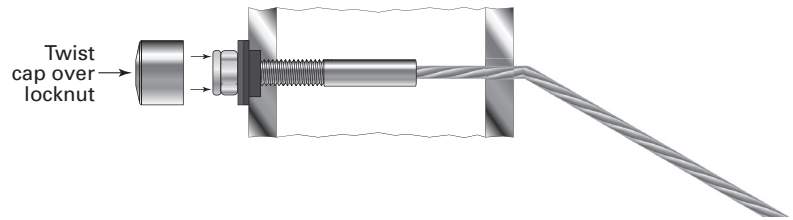

3. Return to the swageless terminal. Cut the cable flush with the hole in the back of the fitting using a cut-off wheel.

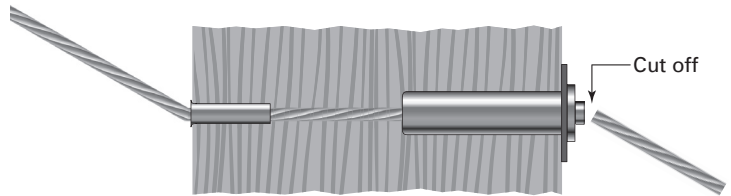

4. Twist the cap onto the lip of the Pull-Lock® fitting.

