

2-in-1 Horizontal Baluster Connectors (Front & Bottom)

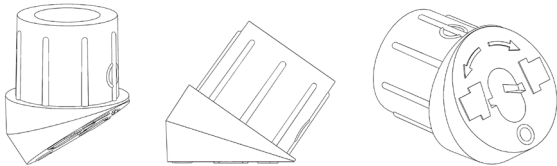

2-in-1 Baluster Stair Connectors (Front, Side & Bottom)

Preparation

Prior to construction, check with your local regulatory agency for special code requirements in your area. Common railing height is 36". Structural support should come from either the continuation of deck support posts that extend up through the deck floor or from railing posts that are bolted to the inside of the rim or outer joist. **6' on-center post spacing is recommended. Never span more than 8' on-center between railing posts.**

In-line railing

Step 1: Measure railing opening from post to post to determine the length of each baluster rail section (fig. 1).

Step 2: Cut top and bottom rails (2x4s) to length and clamp together. Mark top and bottom rails 4-1/2" on-center, starting from the center of the rail (fig. 2).

Step 3: Using a drill driver, screw on baluster connectors at each mark using the screws provided (fig. 3). Apply silicone caulk on each connector to prevent balusters from turning or rattling after installation is complete. The caulk should be on the outside of the connector, where the baluster will make contact with the connector's outer edge.

Note: Specific types of treated lumber are known to corrode aluminum. The baluster connectors provide a barrier between the aluminum balusters and treated lumber to ensure long-term performance.

Step 4: Place the bottom rail between the rail posts, supported by a 3" block (2x4 scrap material works best) (fig. 4). Secure rail to posts using rail connectors (sold separately) and then slide balusters over the bottom connectors. Carefully place top rail over the balusters; working from one end to the other making sure each baluster is seated properly on each connector (fig. 5).

Step 5: Inspect finished railing for proper baluster spacing and secure top rail. Add a cap rail for a finished look (fig. 6).

Step 6: For rail sections longer than 4', support blocks are required. These can be made from leftover 2x4 rail material. Properly position the support block and toe-nail it to the bottom rail and deck board (fig. 7).

Kit contents

- 15 - Aluminum balusters (2.5 balusters required per linear foot of railing)
- 30 - Horizontal baluster connectors
- 10 - Baluster stair connectors

Items you will need

- Rail connectors (optional, sold separately)
- Drill driver
- Tape measure
- Clamps
- Safety glasses
- Carpenter's pencil
- White rubber mallet
- Support blocks (can be cut from scrap rail material)

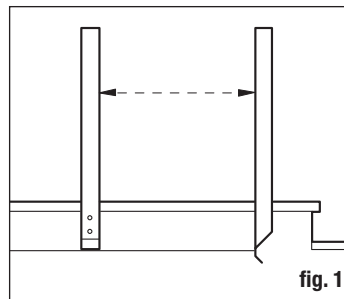

fig. 1

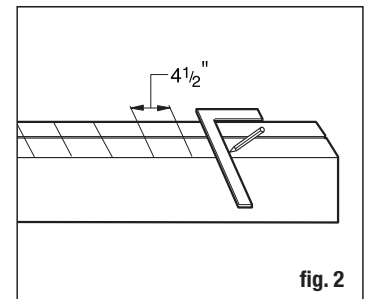

fig. 2

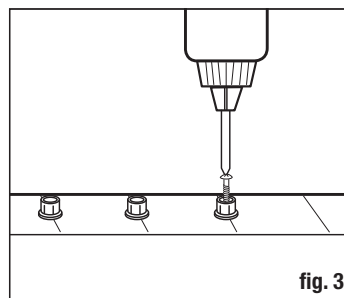

fig. 3

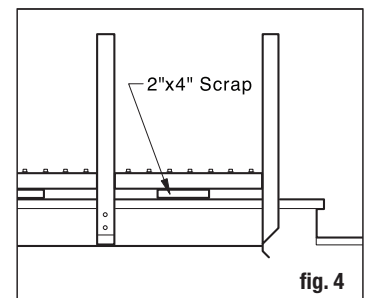

fig. 4

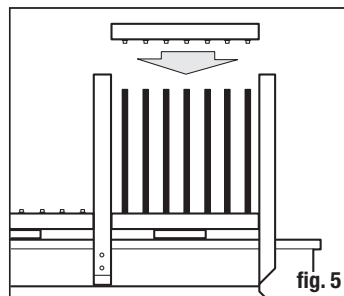

fig. 5

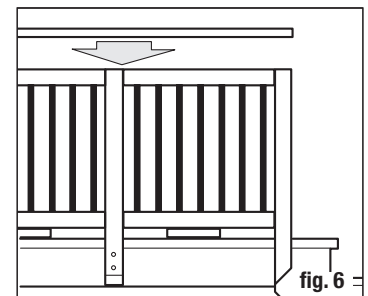

fig. 6

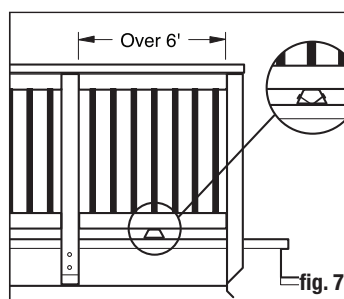

fig. 7

Stair railing

Step 1: Stair rails and balusters can present an installation challenge. Stair baluster connectors create a snug and accurate baluster fit for stair angles ranging from 30 to 35 degrees (fig.1). Cut top and bottom stair rails at the proper angle. Lay top and bottom 2x4 rails alongside the posts and mark.

Step 2: Clamp the top and bottom rails together with the top 2x4 rail inverted. Position rails as shown and mark 5-1/2" on-center, working from the center out to the ends of the rails (fig. 2).

Step 3: Properly position the connectors on the rails. The top and bottom connectors will be facing opposite directions (fig. 3). Screw the connectors in place. To properly set connectors, begin screwing vertically until the screw bites into the wood (fig. 4). Reposition screw to the proper angle and tighten. Do not over-tighten, which can move the assemblies off center.

Step 4: Make sure connectors are properly aligned, apply silicone caulk to each connector and assemble the top and bottom rails with the balusters (fig. 5). Then attach full rail section between the stair rail posts (fig. 6). For stair rail sections longer than 4', support blocks are required. These can be made from leftover 2x4 rail material. Properly position the support block and toe-nail it to the bottom rail and deck board.

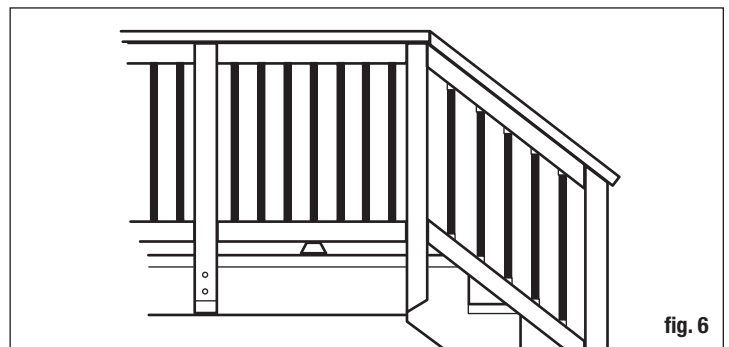
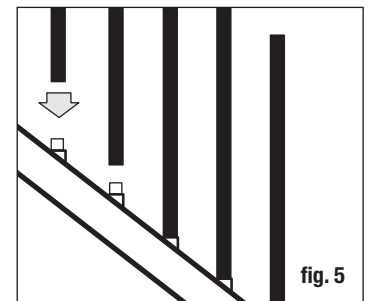
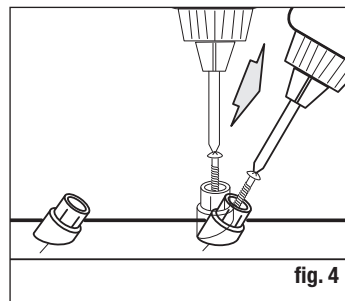
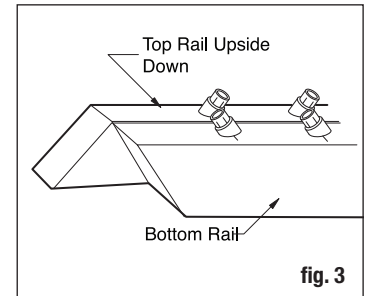
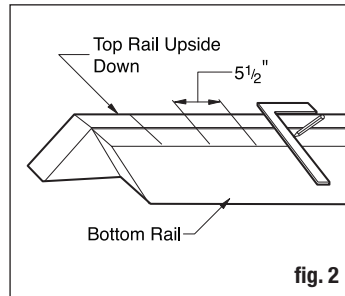
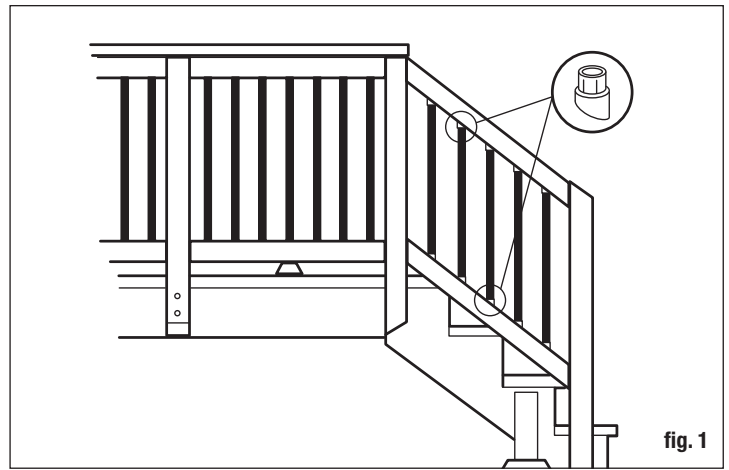

THE DIAGRAMS AND INSTRUCTIONS IN THIS BROCHURE ARE FOR ILLUSTRATION PURPOSES ONLY AND ARE NOT MEANT TO REPLACE A LICENSED PROFESSIONAL. ANY CONSTRUCTION OR USE OF THE PRODUCT MUST BE IN ACCORDANCE WITH ALL LOCAL ZONING AND/OR BUILDING CODES. THE CONSUMER ASSUMES ALL RISKS AND LIABILITY ASSOCIATED WITH THE CONSTRUCTION OR USE OF THIS PRODUCT. THE CONSUMER OR CONTRACTOR SHOULD TAKE ALL NECESSARY STEPS TO ENSURE THE SAFETY OF EVERYONE INVOLVED IN THE PROJECT, INCLUDING, BUT NOT LIMITED TO, WEARING THE APPROPRIATE SAFETY EQUIPMENT. EXCEPT AS CONTAINED IN THE WRITTEN LIMITED WARRANTY, THE WARRANTOR DOES NOT PROVIDE ANY OTHER WARRANTY, EITHER EXPRESS OR IMPLIED, AND SHALL NOT BE LIABLE FOR ANY DAMAGES, INCLUDING CONSEQUENTIAL DAMAGES.