

Issue Date: 10-01-2015
Revision Date: 12-11-2024
Renewal Date: 12-31-2025

DIVISION: 06 00 00 – WOOD, PLASTICS AND COMPOSITES
Section: 06 50 00 – Structural Plastics
Section: 06 53 00 – Plastic Decking

REPORT HOLDER:

Eovations, LLC
5 Meadowcraft Parkway
Selma, AL 36701
(334) 872-1580
www.Eovationsllc.com

REPORT SUBJECT:

Eovations™ Deck Boards

Eovations™ Porch Boards
Deckorators® Vault Deck Boards also known as
Deckorators Voyage and *Eovations Tractio*
Deckorators® Frontier Deck Boards
Deckorators® Voyage Varied-Plank Decking
Deckorators® Dock and Deck Board
SLS Composite Deck Boards
Ultra Light Deck Boards

1.0 SCOPE OF EVALUATION

1.1. This research report addresses compliance with the following Codes:

- 2024, 2021, 2018 *International Building Code®* (IBC)
- 2024, 2021, 2018 *International Residential Code®* (IRC)

NOTE: This report references the most recent edition of the codes cited Section numbers in earlier editions may differ.

1.2. Deck and porch boards have been evaluated for the following properties:

- Structural Performance
- Durability
- Surface Burning

1.3. *Eovations™, Deckorators®, SLS Composite, Ultra Light* deck and *Porch* boards are intended for use as a walking surface on exterior decks, balconies, porches, and walkways, including stairs in One- and Two-Family Dwellings regulated

by the IRC and other construction types regulated by the IBC in accordance with IBC Sections 705.2.3 [1406.3] *Combustible projections*, where fire-resistance rated floor construction is not required for the deck or balcony.

2.0 STATEMENT OF COMPLIANCE

Eovations™, Deckorators®, SLS Composite, Ultra Light deck and *porch* boards comply with the Codes listed in Section 1.1, for the properties stated in Section 1.2 and uses stated in Section 1.3, when installed as described in this report, including the Conditions of Use stated in Section 6.0.

2.1 2024 IBC and IRC Evaluation Reports

The Intertek CCRR is an *Evaluation Report* for approval of an alternate material, design, or method of construction in accordance with Section 104.2.3.6.1 of the 2024 IBC and Section R104.2.2.6.1 of the 2024 IRC.

3.0 DESCRIPTION

3.1. *Eovations™, Deckorators®, SLS Composite, Ultra Light Deck Boards* are thermoplastic composite deck boards, co-extruded using proprietary inorganic fillers and polypropylene (PP) materials with a polypropylene cap.

3.2. Finished deck boards are available in solid or slotted rectangular profiles.

3.2.1. *Eovations™* deck boards are provided with nominal dimensions of 5.3 inches wide and 0.75 inches thick. See Figure 1.

3.2.2. *SLS Composite* and *Ultra Light* deck boards are provided with nominal dimensions of 5.2 inches wide and 0.800 inches thick. See Figure 2.

3.2.3. *Deckorators® Vault* and *Frontier* deck boards are provided with nominal dimensions of 5.5 inches wide and 0.835 inches thick. See Figure 3.



545 E. Algonquin Road • Arlington Heights • Illinois • 60005
intertek.com/building





3.2.4. *Deckorators® Voyage Varied-Plank Decking* is provided with nominal dimensions of 3.5 inches, 5.5 inches, 7.25 inches, 9.25 inches, and 11.25 inches wide and 0.835 inch thick. See Figures 6-8.

3.2.5. *Deckorators® Dock & Deck Board* is provided in nominal dimensions of 5.5 inches wide and 1.21 inches thick. See Figure 5.

3.3. *Eovations™ Porch* boards are provided with a tongue and groove profile of nominal dimensions of 3.125 inches wide and 0.835 inches thick. See Figure 4.

3.4. Deck boards may be installed via face-fastening using exterior screws or by using hidden fastener systems.

4.0 PERFORMANCE CHARACTERISTICS

4.1. Deck and porch boards are rated for a uniform live load of 100 lbs/ft.² when installed on support framing spaced at up to 16 or 24 inches (See Table 2).

4.2. Deck and porch boards used as stair treads are rated for the code-prescribed concentrated load equal to 300 lbs. when installed as a continuous board over a minimum of two spans with the maximum specified in Table 2.

4.3. Deck and porch boards have wind uplift resistance ratings as determined by the fastening method. See Table 2.

4.4. Materials used have a flame spread index no greater than 200 when tested in accordance with ASTM E84.

4.5. Materials are deemed equivalent to preservative treated or naturally durable wood for resistance to weathering effects, attack from termites and fungus decay.

4.6. Structural performance has been demonstrated for a temperature range from -20°F to 125°F.

5.0 INSTALLATION

Installation shall be in accordance with the manufacturer's installation instructions and this report. Where differences occur between this report and the manufacturer's installation instructions, this report shall govern.

5.1. Solid deck boards may be installed with #7 x 1-7/8-inch Camo™ coated steel screw hidden fasteners. Two fasteners are required at every joist. 11.25 inches wide solid deck boards may also be installed with #8 x 2-1/2 in stainless steel deck screws. Two fasteners are required at every joist.

5.2. Slotted deck boards are installed with the *Equator®*, *Camo™*, *EdgeClip* and *EdgeX Clip Screw hidden fasteners*, *Stowaway™*, or *DeckWise* hidden fastener systems. For the *Equator®* and *Stowaway™* hidden fasteners, one fastener is required at every joist. See Figure 9.

5.3. Tongue and groove porch boards are installed with the "T" or "L" cleat nails. One nail is required at every joist. See Figure 10.

6.0 CONDITION OF USE

The deck board applications identified in this report are deemed to comply with the intent of the provisions of the referenced building codes subject to the following conditions:

6.1. Deck and porch boards placed at an angle other than 90 degrees to the supporting joist will require support framing at a reduced spacing such that the span of the board does not exceed the span rating specified in Table 2).

6.2. The wind uplift resistance rating recognized in this report is based on attachment to treated Southern Pine framing (specific gravity, G=0.55). Installation on wood framing with a lesser specific gravity may result in a lower wind uplift rating.

6.3. Where required by the building official, engineering calculations and details shall be provided. The calculations shall verify that the anchorage complies with the building code for the type of framing and condition of the supporting construction.

6.4. Compatibility of the supporting construction materials with all metal fasteners are subject to approval by the code official.

6.5. Only those types of fasteners and fastening methods described in this report have been evaluated for the installation of the deck boards; other methods of attachment are outside the scope of this report.





6.6. *Eovations™, Deckorators®, SLS Composite, Ultra Light Deck and Porch* boards are manufactured in accordance with the manufacturer's approved quality control system with inspections by Intertek Testing Services NA, Inc.

7.0 SUPPORTING EVIDENCE

- 7.1. Manufacturer's drawings and installation instructions.
- 7.2. Reports of testing and engineering analysis demonstrating compliance with ICC-ES AC174, Acceptance Criteria for Deck Board Span Ratings and Guardrail Systems (Guards and Handrails), revised December 2014, and ASTM D7032-21 [17].
- 7.3. Documentation of an Intertek approved quality control system for the manufacturing of products recognized in this report.

8.0 IDENTIFICATION

Eovations™, Deckorators®, SLS Composite, Ultra Light deck and porch boards produced in accordance with this report shall be identified with labeling on the individual deck boards that includes the following information: Name and/or trademark of manufacturer; the Code Compliance Research Report identification and number (CCRR-0195); and the following statement: "See Intertek CCRR-0195 at <https://bpdirectory.intertek.com> for uses and performance levels."



9.0 OTHER CODES

This section is not applicable.

10.0 CODE COMPLIANCE RESEARCH REPORT

- 10.1. Approval of building products and/or materials can only be granted by a building official having legal authority in the specific jurisdiction where approval is sought.
- 10.2. Code Compliance Research Reports shall not be used in any manner that implies an endorsement of the product by Intertek.
- 10.3. Reference to the Intertek website address: <https://bpdirectory.intertek.com> is recommended to ascertain the current version and status of this report.

This Code Compliance Research Report ("Report") is for the exclusive use of Intertek's Client and is provided pursuant to the agreement between Intertek and its Client. Intertek's responsibility and liability are limited to the terms and conditions of the agreement. Intertek assumes no liability to any party, other than to the Client in accordance with the agreement, for any loss, expense or damage occasioned by the use of this Report. Only the Client is authorized to permit copying or distribution of this Report and then only in its entirety, and the Client shall not use the Report in a misleading manner. Client further agrees and understands that reliance upon the Report is limited to the representations made therein. The Report is not an endorsement or recommendation for use of the subject and/or product described herein. This Report is not the Intertek Listing Report covering the subject product and utilized for Intertek Certification and this Report does not represent authorization for the use of any Intertek certification marks. Any use of the Intertek name or one of its marks for the sale or advertisement of the tested material, product or service must first be approved in writing by Intertek.





TABLE 1 - PROPERTIES EVALUATED

PROPERTY	APPLICABLE CODE SECTIONS ¹	
	2024 IBC	2024 IRC
Physical properties	2612	R507.2.2
Surface burning characteristics	2612.3	R507.2.2.2
Combustible projections	705.2	R302.1
Live loads	1607	R301.5
Wind loads	1609	R301.2.1
Anchorage	1604.8.3	R507.8.9

¹Section numbers pertain to the most recent edition cited in Section 1.1 of this Report.

TABLE 2 – SPAN AND UPLIFT RESISTANCE RATINGS

Product	Live Load (in / psf)	Stair Tread Support Spacing ⁽¹⁾	Fastener ⁽²⁾	Uplift Resistance
Eovations™ Deck Boards <i>Eovations™ Tractio</i> <i>Deckorators® Vault Deck Boards</i> <i>Deckorators® Voyage</i> <i>Deckorators® Frontier Deck Boards</i> <i>SLS Composite Deck Boards</i> <i>Ultra Light Deck Boards</i>	16 / 100	9 inches	#7 x 1-7/8 inches <i>Camo™</i> coated steel screw	77 psf
			<i>Equator®</i> Hidden Fastener	44 psf
			<i>Stowaway™</i> Hidden Fastener	105 psf
<i>Eovations™</i> Porch	16 / 100	9 inches	"L" cleat nail	127 psf
			"T" cleat nail	138 psf
3.5", 5.5", 7.25" <i>Deckorators®</i> <i>Voyage Varied-Plank Decking</i>	16 / 100	9 inches	<i>Camo® EdgeClip Screw and EdgeX clip Screw</i>	133 psf
			<i>Stowaway™ Hidden Fastener</i>	105 psf
			<i>Camo® EdgeClip Hidden Fastener</i>	150 psf
			<i>DeckWise Hidden Fastener</i>	150 psf
9.25" <i>Deckorators® Voyage</i> <i>Varied-Plank Decking</i>	16 / 100	9 inches	#7 x 1-7/8 inches <i>Camo™</i> coated steel screw	94 psf
			<i>Stowaway™ Hidden Fastener</i>	116 psf
			<i>Camo® EdgeClip Hidden Fastener</i>	85 psf
11.25" <i>Deckorators® Voyage</i> <i>Varied-Plank Decking</i>	16 / 100	8 inches ⁽³⁾	Two #8 x 2-1/2 inches stainless steel deck screws	197 psf
			#7 x 1-7/8 inches <i>Camo™</i> coated steel screw	97 psf
<i>Deckorators® Dock & Deck Board</i>	24 / 100	12 inches	<i>Camo®</i> Edge Deck Screw	125 psf

⁽¹⁾ Continuous two-span installation.

⁽²⁾ As described in Table 3.

⁽³⁾ 11.25" stair treads are secured with three #8 x 2-1/2 inches stainless steel deck screws at each stair support.





TABLE 3 - FASTENER DESCRIPTION AND USES

Generic Fastener Description	Uses	Detailed Fastener Description
#8 x 2-1/2 inches stainless steel deck screw	For 11.25" wide solid deck boards (see Section 5.1)	9 TPI, 2.468 in overall length, 0.177 in major diam., 0.115 in minor diam., 0.128 in shank diam., 0.250 in head diam., star drive, trim head, type 17 point
#7 x 1-7/8 inches Camo™ coated steel screw	Hidden fasteners for solid deck boards (see Section 5.1)	9 TPI with a 0.43-inch length of reverse pitch, 1.85-inch overall length, 0.162-inch major diameter, 0.197-inch head diameter, star drive trim head, pinch point
<i>Camo® Edge Deck Screw</i> (Figure 9)	Hidden fastening system for solid deck boards (See Section 5.1)	#7 x 2-1/4-inch Screw, 401 Stainless Steel
<i>Camo® Edge Clip and EdgeX Clip Screw</i> (Figure 9)	Hidden fastening system for grooved deck boards (See Section 5.2)	#7 x 2-1/4-inch Screw, 401 Stainless Steel
<i>Equator® Hidden Fastener</i> (Figure 9)	Hidden Fastening system for slotted deck boards (see Section 5.2)	Polypropylene Clips 10 TPI with a 2-inch overall length, 0.170-inch major diameter, 0.242-inch head diameter, square drive trim head, type 17 point
<i>Stowaway™ Hidden Fastening System</i> (Figure 9)	Hidden Fastening system for slotted deck boards (see Section 5.2)	Nylon Composite Clips fastened to joists with #7 by 1-5/8-inch-long stainless-steel screw (0.164-inch major diameter, 0.124-inch shank diameter, 0.235 in head diameter)
<i>Deck Wise Hidden Fastener</i> (Figure 9)	Hidden Fastening system for slotted deck boards (see section 5.2)	#8 by 2 in long (0.178 in major dia., 0.117 in minor dia., 0.134 in shank dia., 1.360 in threaded shank, 8 TPI, type 17 point) grade 305 stainless steel, T15 drive,
"L" cleat nail (Figure 10)	Fastening system for tongue and groove porch boards (see Section 5.2)	16-gauge x 2 inches Freeman "L" Cleat Flooring Nail installed using a pneumatic flooring tool
"T" cleat nail (Figure 10)	Fastening system for tongue and groove porch boards (see Section 5.2)	16-gauge x 2 inches Freeman "T" Cleat Flooring Nail installed using a pneumatic flooring tool



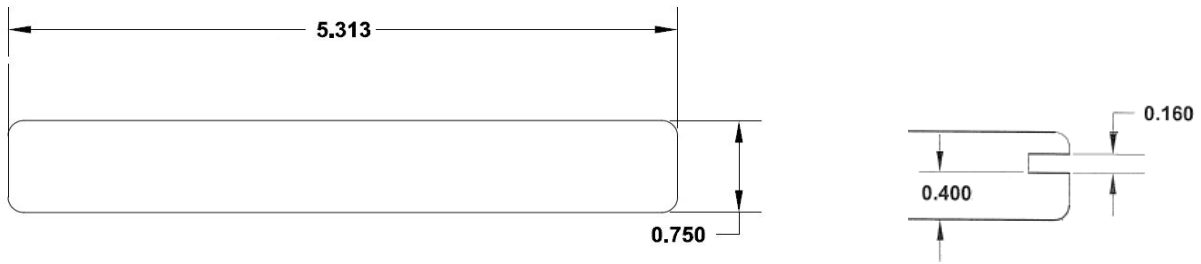

FIGURE 1 – EOVATIONS™ DECK BOARD PROFILE

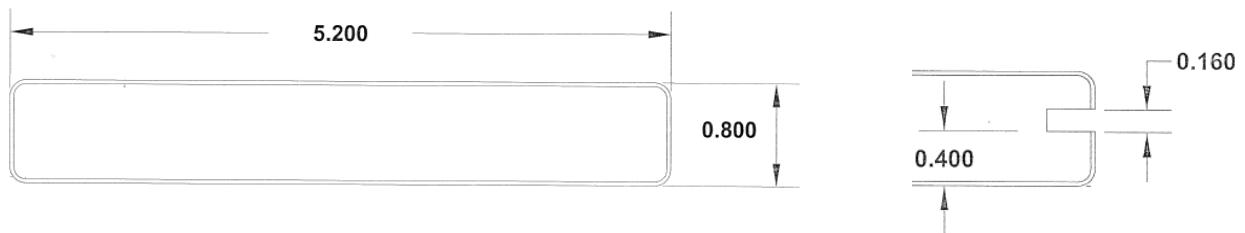

FIGURE 2 – SLS COMPOSITE AND ULTRA LIGHT DECK BOARD PROFILES

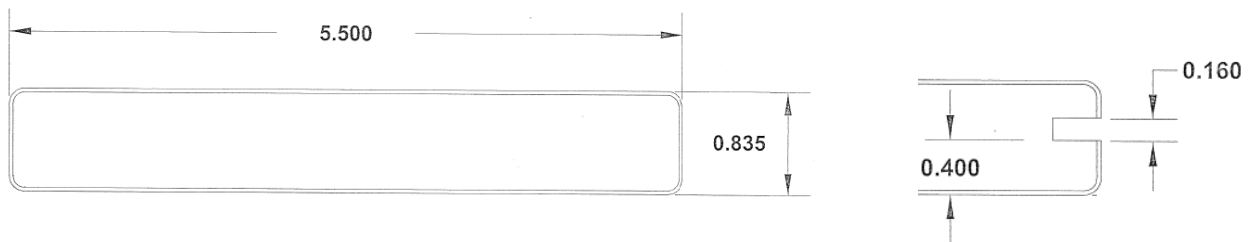

FIGURE 3 – DECKORATORS® VAULT, VOYAGE, FRONTIER AND EOVATIONS™ TRACTIO DECK BOARD PROFILES



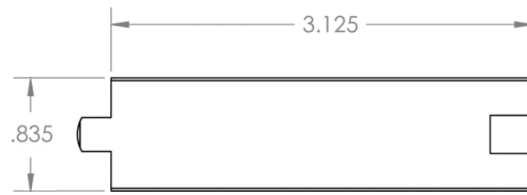

FIGURE 4 – EOVATIONS™ PORCH PROFILE (TONGUE AND GROOVE)

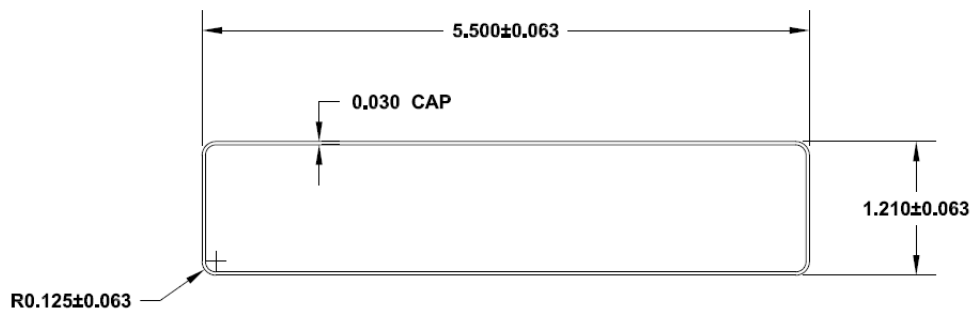

FIGURE 5 – DECKORATORS® DOCK & DECK BOARD

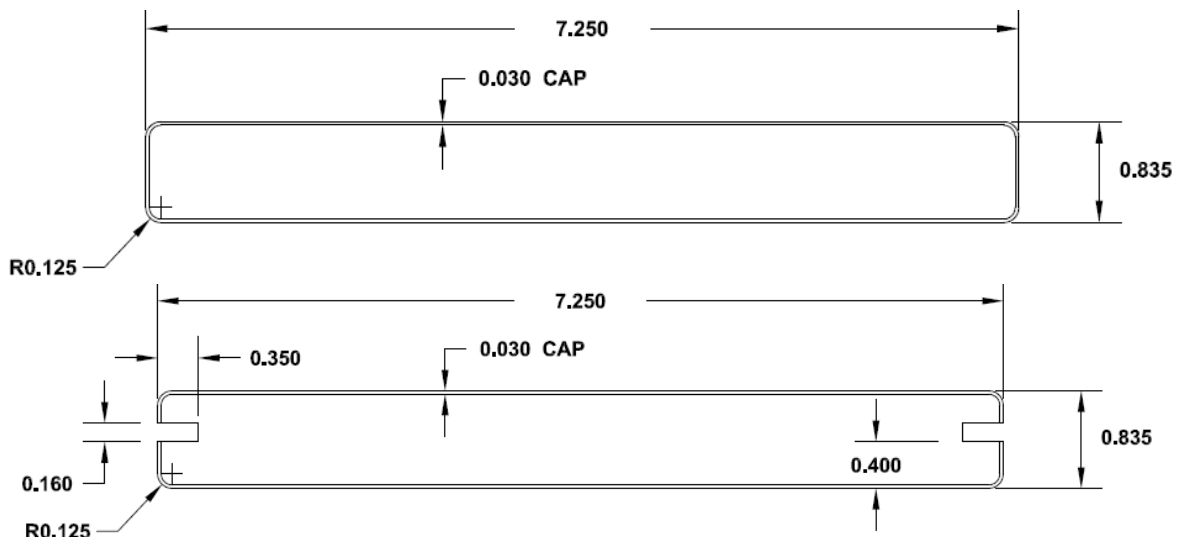

FIGURE 6 – 7.25\"/>



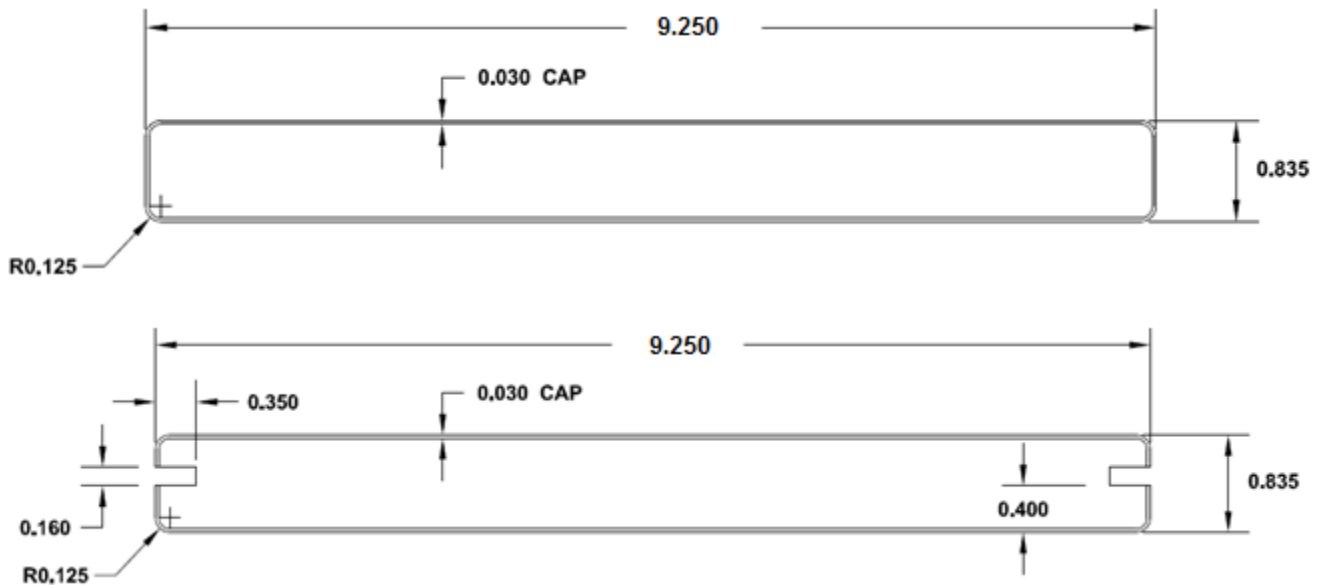

FIGURE 7 – 9.25" DECKORATORS® VOYAGE VARIED-PLANK DECKING

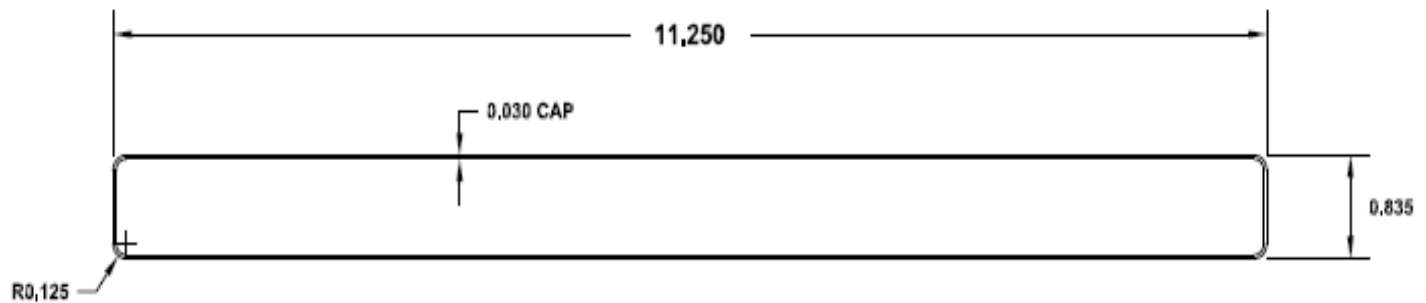
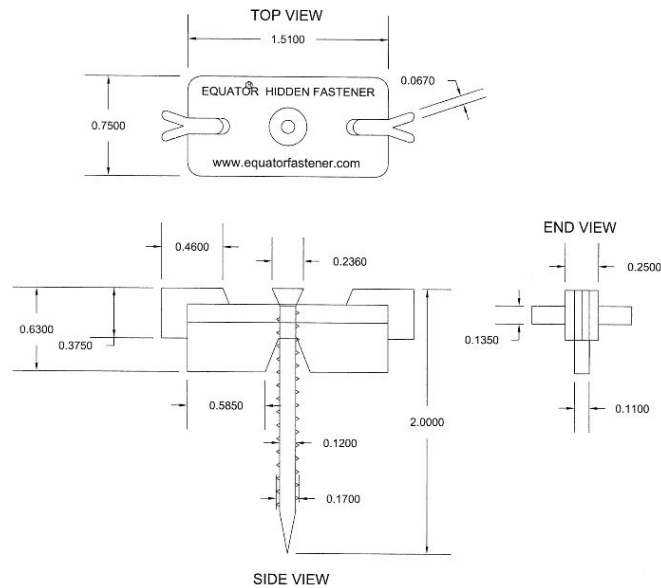
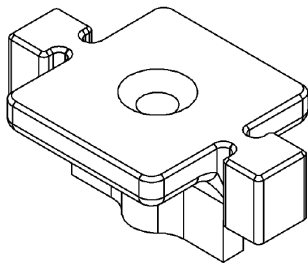

FIGURE 8 – 11.25" DECKORATORS® VOYAGE VARIED-PLANK DECKING





Equator® Hidden Fastener System



Stowaway™ Hidden Fastener System

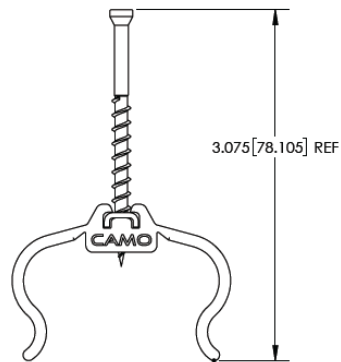

EdgeClip Hidden Fastener System

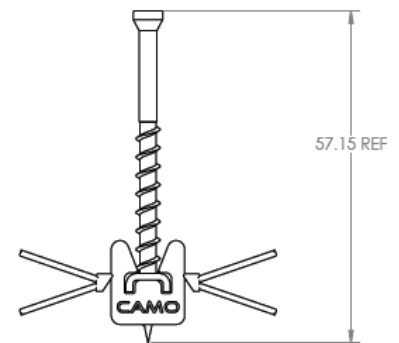

EdgeXClip Hidden Fastener System

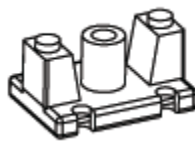

Deck Wise Hidden Fastener System

FIGURE 9 – DECK BOARD FASTENERS



"L" Cleat Nail (16 gauge, 2")



"T" Cleat Nail (16 gauge, 2")

FIGURE 10 – PORCH FASTENERS



Intertek

